



**ANCRA AUSTRALIA  
MOTOR BODY BUILDERS  
CATALOGUE**



**FEBRUARY 2008**

# INDEX

<u>Product</u>	<u>Page Number</u>
Front Cover	1
Index	2
Ancra Branches – Australia wide	2
Body Builders Track	3
Body Builders Track	4
Bars and Beams	5
Spring Bolts & Door Locks	5
Hold Back Accessories	6
Floor Rings	7
Jacks	7
Tensioners	8
Pallet Skates	8
Anti Luce	9
Twistlocks	9
Door Locks	10/11
Door Hinges & Accessories	12/13
U Bolts	13
Van Accessories	14
Rubber Products	15
Retract-A-Roll II	16/17
Lift-A-Deck II	18/19
Product Overview	20



## ANCRA BRANCHES - AUSTRALIA WIDE



### VICTORIA/TASMANIA

Phone: (03) 9587 6700  
 Fax: (03) 9587 1977  
 Address: 250 Governor Road, Braeside, Victoria 3169  
 Email: [sales@ancraustralia.com](mailto:sales@ancraustralia.com)  
 Website: [www.ancranz.co.nz](http://www.ancranz.co.nz)



### NEW SOUTH WALES/ACT

Phone: (02) 9728 7422  
 Fax: (02) 9723 1399  
 Address: 17/20 Alfred Road, Chipping Norton, New South Wales 2170  
 Email: [sydney@ancraustralia.com](mailto:sydney@ancraustralia.com)  
 Website: [www.ancranz.co.nz](http://www.ancranz.co.nz)



### SOUTH AUSTRALIA/NORTHERN TERRITORY

Phone: (08) 8359 8423  
 Fax: (08) 8359 8775  
 Address: Warehouse 2, CNR South & Grand Junction Road Wingfield SA 5013  
 Email: [ancrasa@ancraustralia.com](mailto:ancrasa@ancraustralia.com)  
 Website: [www.ancranz.co.nz](http://www.ancranz.co.nz)



### QUEENSLAND BRANCH

Phone: (07) 3272 7227  
 Fax: (07) 3272 7320  
 Address: Unit 12, 121 Kerry Road, Archerfield, Queensland 4108  
 Email: [ancraqd@iprimus.com.au](mailto:ancraqd@iprimus.com.au)  
 Website: [www.ancranz.co.nz](http://www.ancranz.co.nz)



### WESTERN AUSTRALIA BRANCH





Phone: (08) 9353 4644  
 Fax: (08) 9353 2799  
 Address: Unit 10, 524 Abernethy Road, Kewdale, Western Australia 6105  
 Email: [ancrawa@ancraustralia.com](mailto:ancrawa@ancraustralia.com)  
 Website: [www.ancranz.co.nz](http://www.ancranz.co.nz)

## BODY BUILDERS TRACK

### ANCRA STEEL WINCH SLIDE TRACK – SUITABLE FOR ANCRA SLIDE ON WINCHES

PART NUMBER	DESCRIPTION	PRODUCT PHOTO
42357-2.4MTR	<b>2.4 METRE WINCH SLIDE TRACK</b> Weight 14.00kg Length 2400mm Width 115mm Height 34mm Thickness 3mm	
42357-3.0MTR	<b>3.0 METRE WINCH SLIDE TRACK</b> Weight 15.60kg Length 3000mm Width 115mm Height 34mm Thickness 3mm	
42357-5MM-3.0MTR	<b>3.0 METRE 5MM WINCH SLIDE TRACK</b> Weight 16.70kg Length 3000mm Width 115mm Height 34mm Thickness 5mm	

### E COMBINATION TRACK FULLY GALVANISED AND SUITABLE FOR SHORING BARS, DECKING BEAMS AND FITTINGS

40837-11C	<b>3.0M GALVANISED E COMBINATION TRACK</b> Weight 6.30kg Length 3000mm Hole Size 25mm Width 129mm Thickness 12mm Screw Size 5mm Material 3mm	
40837-13C	<b>6.0M GALVANISED E COMBINATION TRACK</b> Weight 12.72kg Length 6000mm Hole Size 25mm Width 129mm Thickness 12mm Screw Size 5mm Material 3mm	
ANC1022	<b>E SERIES END CAP</b> Suitable for all types of E track	
ANC3012	<b>E SERIES BEAM SOCKET</b> F series beam socket with multiple uses	

## BODY BUILDERS TRACK (Continued)

**F TRACK AVAILABLE IN BOTH GALVANISED OR STAINLESS STEEL SUITABLE FOR SHORING BARS AND FITTINGS**

**40849-12LPG**

**3.66M GALVANISED F TRACK**

Weight 5.56kg  
 Length 3660mm  
 Hole Size 25mm  
 Width/Thickness 83mm/11mm  
 Screw Size 5mm  
 Material 3mm



**40849-14LP**

**6.0M GALVANISED F TRACK**

Weight 9.40kg  
 Length 6000mm  
 Hole Size 25mm  
 Width/Thickness 83mm/11mm  
 Screw Size 5mm  
 Material 3mm



**40849-12ST/ST**

**3.66M STAINLESS STEEL F TRACK**

Weight 4.45kg  
 Length 3660mm  
 Hole Size 25mm  
 Width/Thickness 83mm/11mm  
 Screw Size 5mm  
 Material 3mm



**40849-14ST/ST**

**6.0M STAINLESS STEEL F TRACK**

Weight 7.30kg  
 Length 6000mm  
 Hole Size 25mm  
 Width/Thickness 83mm/11mm  
 Screw Size 5mm  
 Material 3mm



**ANC3532**

**3.0M GALVANISED F TRACK**

Length 3000mm  
 Hole Size 25mm  
 Width/Thickness 82mm/12mm  
 Screw Size 5mm  
 Material 2.5mm



**ANC3534**

**6.0M GALVANISED F TRACK**

Length 5800mm  
 Hole Size 25mm  
 Width/Thickness 82mm/12mm  
 Screw Size 5mm  
 Material 2.5mm



**ANC1021**

**F SERIES END CAP**

Suitable for all types of F track



**49201-12**

**F SERIES BEAM SOCKET**

F series beam socket with multiple uses



## BARS AND BEAMS

**43638-51-10PK-W**

**E SERIES DECKING BEAM**

Weight	8.42kg
Length – Min/Max	2340-2610mm
Height/Width	82mm/66mm
Thickness	3mm
Working Limit	1000kg
Working Limit	1000kg



**43627-12**

**E SERIES DECKING BEAM CHANNEL ASSEMBLY**

Adjustable channel assembly for decking beams



**49439-16-18**

**F SERIES STANDARD SHORING BAR**

Weight	5.72kg
Length – Min/Max	2245-2450mm
Width	42mm
Thickness	2mm
Working Limit	227kg
Tapered End Plug	24mm



**49439-11**

**F SERIES ADJUSTABLE SHORING BAR**

Weight	9.12kg
Length – Min/Max	2170-2570mm
Width	42mm
Thickness	3mm
Working Limit	300kg
Tapered End Plug	22mm



**43782-15-01A**

**LARGE CARGO STA BAR**

Length – Min/Max	2225mm-2565mm
------------------	---------------

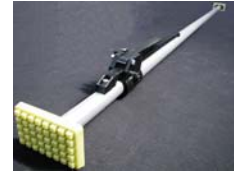

**43782-15-01**

**SMALL CARGO STA BAR**

Length – Min/Max	1102mm-1830mm
------------------	---------------



## SPRING BOLTS AND DOOR LOCKS

**ANC1509**

**SPRING BOLT MILD STEEL ZINC PLATED**

Handle width	65MM
Plate length	75MM
Bolt width	12.5MM



**ANC1516**

**SPRING BOLT MILD STEEL ZINC PLATED**

Handle width	105MM
Plate length	119MM
Bolt width	16MM



**ANC1513**

**SIDE DOOR HOLDBACK HINGE - TIPPER**

Tipper Hinge



## HOLD BACK ACCESSORIES

ANC2082

HOLD BACK ARM POLISHED STAINLESS STEEL



ANC2085

HOLD BACK ARM MILD STEEL ZINC PLATED



ANC2086

HOLD BACK CATCH MILD STEEL ZINC PLATED



ANC2097

HOLD BACK ARM POLISHED STAINLESS STEEL



ANC2098

HOLDBACK CATCH POLISHED STAINLESS STEEL



ANC2803

PLASTIC PROTECTION - ARM  
SUITS ANC2085



ANC2804

PLASTIC PROTECTION - CATCH  
SUITS ANC2086



### HOLD BACK DIMENSIONS

PART NO	A	B	C	D	E
ANC2085	89MM	24MM	64MM	52MM	41MM
ANC2086		29MM	82MM	61MM	45MM
ANC2097	90MM	30MM	80MM	66MM	45MM
ANC2098		30MM	78MM	62MM	44MM
ANC2803		31MM	85MM	61MM	59MM
ANC2804		31MM	85MM	61MM	59MM

## FLOOR RINGS

**ANC3002**

**FLOOR RING RECESSED ZINC PLATED**

Length 95mm  
 Width/Thickness 102mm/11mm  
 Ring size/ Material 25mm/3mm  
 Screw size 5mm  
 Break limit 2000kg

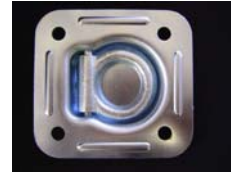

**ANC3004**

**RECESSED FLOOR RING ZINC PLATED**

Length 105mm  
 Width/Thickness 125mm/ 11mm  
 Ring size/Material 25mm/3mm  
 Screw size 5mm  
 Break limit 2000kg



**ANC3006**

**RECESSED FLOOR RING ZINC PLATED**

Length 150mm  
 Width/Thickness 125mm/ 11mm  
 Ring size/Material 25mm/3mm  
 Screw size 5mm  
 Break limit 2000kg



**45545-15**

**LOW PROFILE PAN FITTING 4 INCH**

Polyethylene collar and zinc plated ring  
 Break limit 1600lb  
 Working limit 500lb



## JACKS

**ANC008**

**8 TONNE BOTTLE JACK WITH HANDLE**

8000kg safe working load  
 Complies to AS/ANZ 2693:1993



**ANC012**

**12 TONNE BOTTLE JACK WITH HANDLE**

12000kg safe working load  
 Complies to AS/ANZ 2693:1993



**ANC016**

**16 TONNE BOTTLE JACK WITH HANDLE**

16000kg safe working load  
 Complies to AS/ANZ 2693:1993



**ANC020**

**20 TONNE BOTTLE JACK WITH HANDLE**

20000kg safe working load  
 Complies to AS/ANZ 2693:1993



## TENSIONERS

**RT1000**

**RATCHET CURTAIN TENSIONER RIGHT HAND**  
For sliding curtains



**RT1000-1**

**RATCHET CURTAIN TENSIONER LEFT HAND**  
For sliding curtains



**RT2000LH**

**CURTAIN RATCHET TENSIONER LEFT HAND**  
Red Handle for sliding curtains



**RT2000RH**

**CURTAIN RATCHET TENSIONER RIGHT HAND**  
Red Handle for sliding curtains



**ANC7108**

**CURTAIN TENSIONER LEFT HAND**



**ANC7109**

**CURTAIN TENSIONER RIGHT HAND**



## PALLET SKATES

**44999-10-03**

**4 RAMP ANCRA PALLET SKATES**  
Including 1 pair of Pallet Skates,  
1 Pallet Skate handle  
Load Capacity 4000kg



## ANTI LUCE

**ANC1507**                    **WELD ON ANTI LUCE 90MM ZINC PLATED**  
Width                            20mm  
Length                            90mm  
Bolt width                      12mm  
Bolt Length                    12mm



**ANC1508**                    **BOLT ON ANTI LUCE M21 ZINC PLATED**



**ANC1511**                    **WELD ON ANTI LUCE 60MM ZINC PLATED SMALL**



**ANC1512**                    **BOLT ON ANTI LUCE M8 ZINC PLATED SMALL**



## TWISTLOCKS

**ANC0750LH**                **TWISTLOCK COMPLETE LONG STEM**  
With extended long stem body



**ANC0750S**                    **TWISTLOCK COMPLETE STANDARD**  
With standard handle



**ANC0750SG**                **STANDARD TWISTLOCK INTERNALS**  
Twistlocks guts standard



**ANC0750SH**                **TWISTLOCK STANDARD HANDLE**



**ANC0750PB**                **TWISTLOCK PIN AND BALL**



## DOOR LOCKS

**ANC1820**

**STANDARD WELD ON KEEPER**

To suit 34mm pipe and features  
Bushes for pipe brackets  
MODEL BE2666



**ANC1820LB**

**PLASTIC BUSH LARGE**

To suit ANC1820



**ANC1820SB**

**PLASTIC BUSH SMALL**

To suit ANC1820



**ANC1832**

**STANDARD DOOR KIT**



**ANC1833**

**STANDARD DOOR KIT**



**ANC1838**

**STANDARD DOOR KIT**



**ANC1840**

**STANDARD DOOR KIT**



## DOOR LOCKS (Continued)

**K350**

**K350 DOOR KIT ¼"**



**K350-ARR**

**ANTI RACKING RING (2) FOR K350**



**K350-LBUSH**

**LARGE BUSH FOR K350 DOOR KIT**



**K350-SBUSH**

**SMALL BUSH FOR K350 DOOR KIT**



**ANC014**

**TRUCK GATE POCKET 4"**



**ANC015**

**GATE POCKET 5"**



**ANC1371**

**GATE POCKET SUIT 4" COAMING**











**ANC1111**

**GATE POCKET SUIT 5" COAMING**



## DOOR HINGES AND ACCESSORIES

<b>ANC2001</b>	<b>HINGE PIN 12MM WITH HEAD</b> Suit DV Series	
<b>ANC2004</b>	<b>HINGE BUTT WELD ON BOLT ON</b> Suit various applications	
<b>ANC2032</b>	<b>SIDE DOOR HINGE ZINC PLATED</b>	
<b>ANC2032S</b>	<b>DOOR HINGE STAINLESS STEEL</b>	
<b>ANC2036</b>	<b>PRESSED HINGE ASSEMBLY STAINLESS STEEL</b> Complete with Nut/Bolt size 6.5mm	
<b>ANC2071</b>	<b>HINGE ASSEMBLY ZINC PLATED</b> Hinge Butt and Split pin	
<b>ANC2072</b>	<b>PRESSED HINGE ASSEMBLY WHITE</b> With Hinge, Butt and Split Pin	
<b>ANC2072B</b>	<b>HINGE BUTT</b> Weld on to suit ANC2072	

## DOOR HINGES AND ACCESSORIES (Continued)

**ANC2072B-SCREW**

**HINGE BUTT SCREW TYPE**  
To suit ANC2072

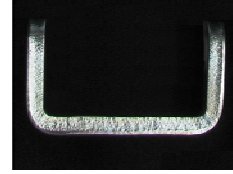

**ANC2072BPS**

**HINGE BUTT, PIN AND SPLIT PIN**  
To suit ANC2072



**ANC2073**

**DOUBLE HINGE BUTT ZINC PLATED**



**ANC2082**

**HOLDBACK ARM STAINLESS STEEL**



### TAILGATE DROP HINGES (FEMALE)

PART NO	DIAMETER	I	L	E	Weight
ANC2052	12MM	25MM	78MM	7MM	0.158KG
ANC2054	14MM	34MM	88MM	8MM	0.280KG
ANC2056	16MM	39MM	97MM	10MM	0.412KG
ANC2058	20MM	50MM	120MM	11MM	0.790KG

### TAILGATE DROP HINGE PINS (MALE)

PART NO	DIAMETER	I	L	E	Weight
ANC2053	12MM	24MM	66MM	6MM	0.134KG
ANC2055	14MM	30MM	82MM	7MM	0.256KG
ANC2057	16MM	39MM	93MM	9MM	0.410KG
ANC2059	20MM	42MM	120MM	10MM	0.650KG

## U BOLTS

LIMITED SELECTION OF STANDARD AND HEAVY DUTY U BOLTS AVAILABLE

**U BOLTS**

**UB 10" – 21"**

**U BOLTS HEAVY DUTY**

**UB HD 10" – 20"**

**SPEADER PLATES**

**UB25 AND UB 35HD**



\*ASK YOUR ANCRA REPRESENTATIVE FOR AVAILABILITY

## VAN ACCESSORIES

**ANC1203**

**THREE STEP LADDER ZINC PLATED**

Pull down for under body mounting  
Length 660mm



**ANC1020**

**END CAP END FITTING**

Suit an Air Flow floor



**ANC1515**

**POP LOCK LARGE CHROME**



**FLCV102**

**CONTAINER VENT PLASTIC LARGE**

395mm x 192mm x 26mm



**FLCC-1301**

**CONTAINER CORNER CASTING TOP LEFT – C**



**FLCC-1302**

**CONTAINER CORNER CASTING TOP RIGHT – D**



**FLCC-1303**

**CONTAINER CORNER CASTING LEFT - A**



**FLCC-1304**

**CONTAINER CORNER CASTING RIGHT – B**



**ANC2606**

**DROP T HANDLE STAINLESS STEEL**



**ANC2606T**

**DROP T HANDLE STAINLESS STEEL  
STRAIGHT TONGUE**



## RUBBER PRODUCTS

ANC5003

CORNER FILLER TABS – DOOR SEAL



ANC5011

TYPE H HARD BACK SOFT SEAL EXTRUSION 5MTR

Length 5m  
Diameter A 20mm

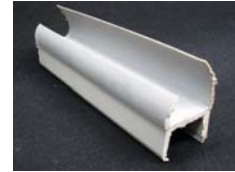

ANC5012

TYPE J HARD BACK SOFT SEAL EXTRUSION 5MTR

Length 5m  
Diameter A 20mm



ANC7104

RUBBER BUMP STOP 1000MM

Length 1000mm  
Height 100mm  
Width 112.5mm

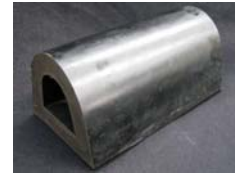

ANC7107

RUBBER BUMP STOP 300MM

Length 300mm  
Height 100mm  
Width 112.5mm



440

50MM DOCKING RUBBER



25 J

DOOR SEAL – BLACK



25 H

DOOR SEAL - BLACK



32 J

DOOR SEAL - BLACK

## RETRACT-A-ROLL II

### Your trailer can lead a double life.

If your trailer could do double duty, think how profitable it would be. Whether the job calls for a flat floor for general freight, or handling containerized air cargo (2-inch rollers, AF systems) or palletized freight (3-inch rollers, PF systems), there's a Retract-A-Roll II system for you. Plus, only Ancra offers an Ironclad™ Unconditional Two-year Air Bag Warranty – the best in the industry.\*

#### Heavy cargo simply rolls on and off the truck.

The Ancra Retract-A-Roll II pneumatic roller track system is the next generation in ultra-efficient material handling systems. Cargo can be loaded and unloaded quickly; speeding turnaround, reducing handling time and lowering labor costs. And regardless of the application, it can reduce deadhead loads and increase trailer utilization.

#### Engineered to weigh less and carry more.

The use of extruded aluminum on main and roller channels saves weight for maximum payload, while adding strength. High-tensile folded steel top plate stands up to forklifts without complaint. Galvanized finish resists corrosion. Rollers are easy to replace in the unlikely event one gets damaged. And the Ancra Wear Guard® offers exclusive 360° air bag protection and the industry's best air bag warranty.

#### Easy to operate.

Simple controls are quickly learned by operators. Primary and back-up controls are housed in a composite weatherproof enclosure. The low-pressure pneumatic system uses the truck's existing air supply. There is no need for an external air source.

#### Flanged roller opening.

Helps prevent debris collection in roller cradle and reduces clean out requirement. It also increases top plate stiffness.

#### Exclusive safety interlock.

If rollers are not lowered by the operator, a control valve automatically lowers rollers when the vehicle's brakes are released.

#### Easy to operate.

Low pressure pneumatic system runs off your truck's air supply. No other air supply is needed.

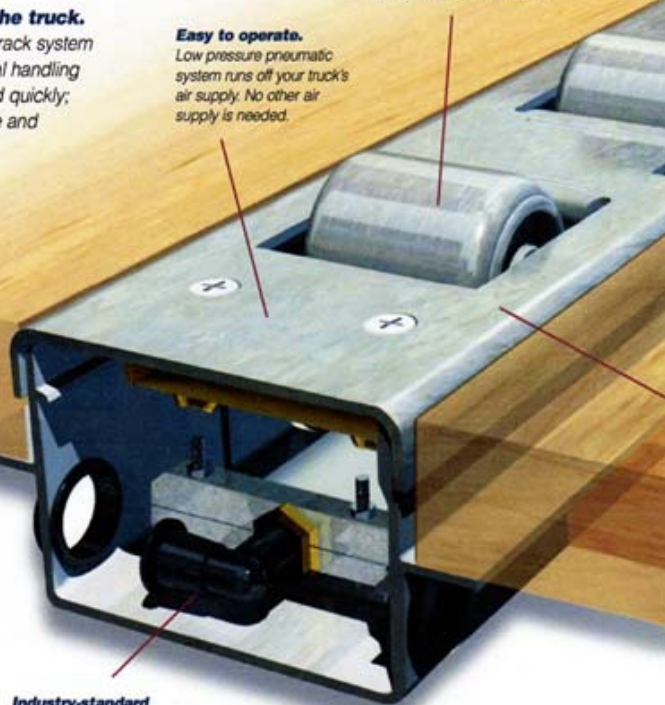

#### Industry-standard connectors.

Standard DOT fittings and 3/8" air line used throughout for reliability, serviceability and for reduced cycle times.



#### Centralized controls.

Easy-to-use controls are housed in a weatherproof container.

# RETRACT-A-ROLL II (continued)

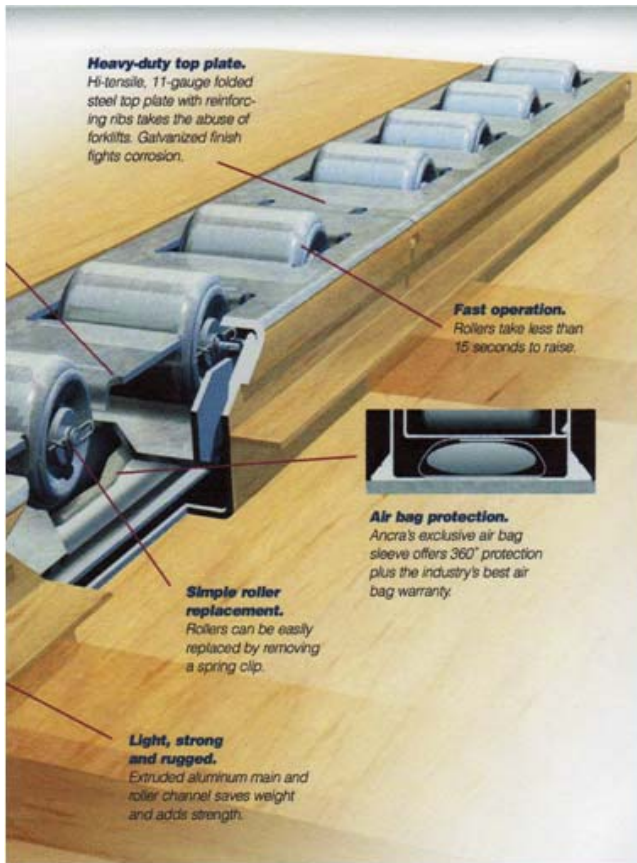

**Heavy-duty top plate.**

Hi-tensile, 11-gauge folded steel top plate with reinforcing ribs takes the abuse of forklifts. Galvanized finish fights corrosion.

**Fast operation.**

Rollers take less than 15 seconds to raise.



**Air bag protection.**

Ancra's exclusive air bag sleeve offers 360° protection plus the industry's best air bag warranty.

**Simple roller replacement.**

Rollers can be easily replaced by removing a spring clip.

**Light, strong and rugged.**

Extruded aluminum main and roller channel saves weight and adds strength.

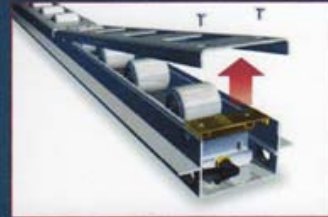

**Easier top plate removal.**

The unique, patented Ancra top plate retention system needs only two screws and two anchor pins per track module which significantly reduces the time for inspection and maintenance. Heavy-duty retention plate with welded nuts ensures long life.



**Better design.**

The patented Ancra Retractable-A-Roll II uses internal stops in the main channel to limit the roller channel lift. Competitors' roller track designs use the top plate as the roller channel stop, and require more fasteners to hold it in place. Rollers are available in 2-inch (AF-air freight) and 3-inch (PF-palletized freight) widths.

**Easy installation.**

Flanges on the side of the track make installation easier and help insure a water-tight floor structure. Track is available with bottom-flange mount or center-flange mount to meet your particular application.



**Roller cradle.**

Unique, patented tilt-out design makes inspection and maintenance a breeze.

**Retract-A-Roll II Specifications**

	Retract-A-Roll AF	Retract-A-Roll PF
Track width:	4.2 inches / 107 mm	5.2 inches / 132 mm
Track height:	2.75 inches / 70 mm	2.75 inches / 70 mm
Track weight:	7.2 lbs/ft / 10.7 kg/m (3" roller, 4" pitch)	5.8 lbs./ft. / 8.7 kg/m (2" roller, 6" pitch)
Inflated height:	3.3 inches / 84 mm	3.3 inches / 84 mm
Roller width:	2.0 inches / 51mm (air freight)	3.0 inches / 76mm (palletized freight)
Roller spacing:	4" / 6" straight pitch / 102 / 152 mm	4" straight pitch / 102 mm
Track lengths:	8', 10' and 13' standard 2.4 m, 3m, 4m standard (custom lengths available)	8', 10' and 13' standard 2.4 m, 3m, 4m standard (custom lengths available)
Lifting capacity:	450 lbs / ft / 671 kg/m	450 lbs / ft / 671 kg/m
Bearing capacity: (standard duty)	500 lbs roller / 227 kg roller	500 lbs roller / 227 kg roller
Operating air pressure:	30 psi / 2 bar	30 psi / 2 bar
Control box:	weatherproof composite construction with centralized controls.	weatherproof composite construction with centralized controls.

## LIFT-A-DECK II

### **A patented solution for decking loads in trailer and truck bodies.**

With Ancra's patented adjustable second deck in your trailer can double the amount of palletized freight you can carry. Or you can mix loads with only part of the truck double decked. Either way, you can increase your hauling capacity – and your profits.

For the loads where you need full height, you simply push the adjustable beams to the roof for convenient and safe storage. No more beams left on the loading dock.

The Ancra Lift-A-Deck II® system is the most versatile you can install. With four track styles to choose from, installations can be made on any type of truck construction, including sheet and post. Lift-A-Deck II track can also be used with a wide range of Ancra accessories for cargo containment.

#### **Convenient storage.**

When not in use, beams are easily pushed to the roof for secure storage. No more lost beams.

#### **Easy operation.**

Beams are easily moved by one operator.

#### **Super strength.**

Ancra standard beams have the highest rating in the industry – 2,200 lbs./1,000 kg.

#### **Wide range of accessories.**

Lift-A-Deck II track can be used for securing loads with cargo straps, tie-offs, and decking/shoring beams.

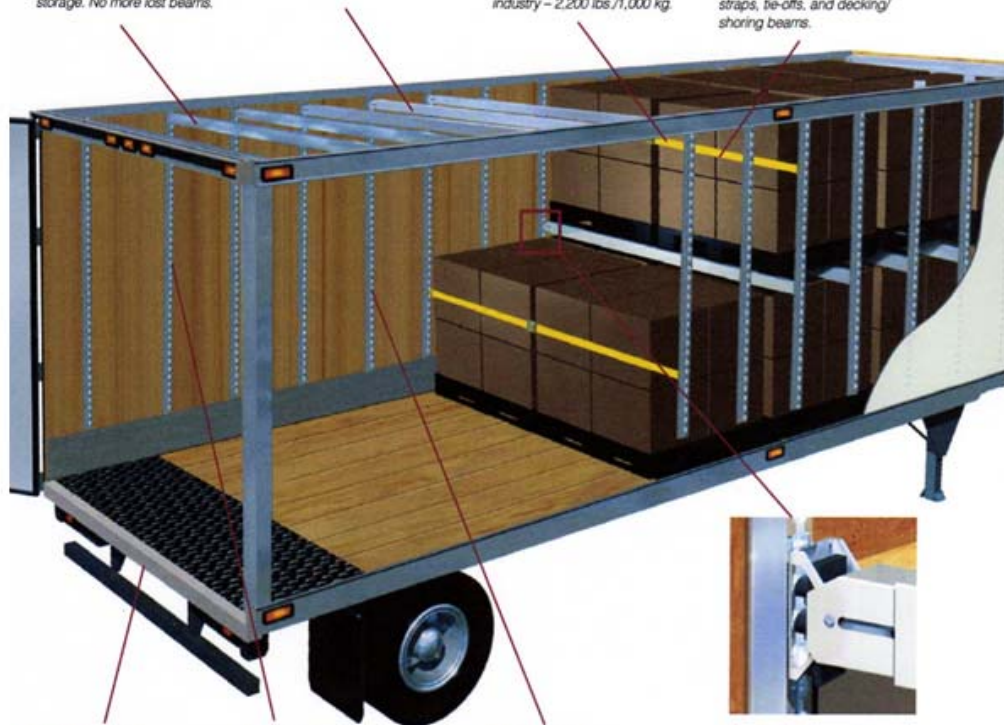

#### **Fits all trailers.**

Available for 96- or 102-inch trailer widths. And height can be specified. Track also can be made as an integral part of sidewall structure.

#### **Versatile.**

Beams can be adjusted in one-inch increments to accommodate various loads within a trailer. Only Ancra offers this much adjustability.

#### **Snag resistant.**

Low profile track design with sloping shoulders helps protect against forklift damage and allows for surface mounting. Standard track length is 72-inches, custom lengths available.

#### **Simple, yet secure.**

Double-engagement lock on the aluminum beam features a simplified trigger release mechanism. Internal locking design helps protect against forklift damage.

# LIFT-A-DECK II (continued)

## Only Ancra gives you so many track options.

- Strongest standard beam in the industry: 2,200 lbs.
- Widest choice of track types to meet every application.
- Beams easily moved by just one operator.
- Beams can be positioned in one-inch increments for most efficient utilization of space.
- Internal locking mechanism to help protect against forklift damage.
- No track lubrication is required

### Lift-A-Deck® II Position Part Numbers



Release Bar  
Part No. 49445-10      Beam Release Bar

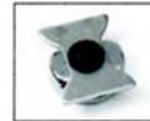

Beam Stop  
Part No. 49384-11

Part No. 49414-53      Channel and Foot Assembly  
Part No. 41332-29      LAD II Beam Extension

### Lift-A-Deck® II Component Part Numbers

Beam access slot is provided as standard for all tracks for easy beam removal and replacement.  
Standard track length is 72 Inches (16 Inch loadable). Custom lengths and an Installation manual are available upon request.

#### Low Profile Single Row S-Track

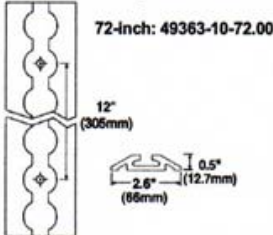

#### Low Profile Single Row Flanged S-Track

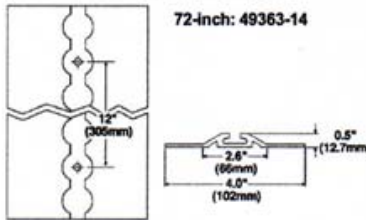

#### Standard Single Row S-Track

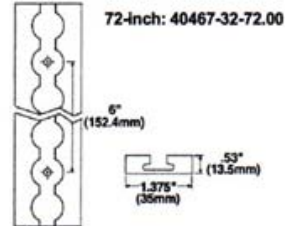

#### Double Row Flanged S-Track

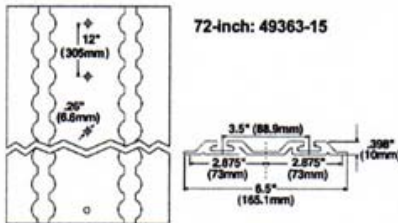

#### Decking Beams

**96-inch Trailers: 49414-14**  
Adjustment range: 87.25 to 97.50 inches  
(221.62 to 247.65 cm)

**102-inch Trailers: 49414-15**  
Adjustment range: 93.5 to 103.75 inches  
(237.49 to 263.53 cm)

Load rating (both sizes): 2200 lbs  
(998 kg)

**Note: Consult trailer or truck body/chassis manufacturer for recommended load capacity of second deck.**

#### Accessories

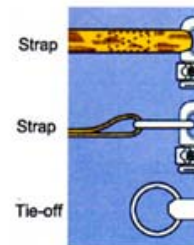

## PRODUCT OVERVIEW

<p><b>STRAP ASSEMBLIES</b></p> <ul style="list-style-type: none"> <li>• Ratchet Buckle Loadbinders</li> <li>• Cam Buckle Assemblies</li> <li>• Overcentre Buckles</li> <li>• Web Stencilling</li> <li>• Assorted Fittings and Hooks</li> <li>• Cargo &amp; Race Car Nets</li> </ul>	<p><b>WINCHES</b></p> <ul style="list-style-type: none"> <li>• Ratchet Cap Winches</li> <li>• Single Boss Slide Rail Winches</li> <li>• Clip-on Winches</li> <li>• Double Boss Winches</li> <li>• Gate Carrier Winches (left and right hand)</li> <li>• Winch Straps – Various lengths &amp; Diameters</li> <li>• Winch Track</li> <li>• Winch Bars</li> </ul>	<p><b>CHAIN</b></p> <ul style="list-style-type: none"> <li>• Chain – Drum</li> <li>• Chain – Various Lengths and Diameters</li> <li>• Chain Kits</li> <li>• Chain Loadbinders</li> <li>• Hooks and Fittings</li> <li>• Pallet Angles</li> </ul>	<p><b>LIFTING EQUIPMENT</b></p> <ul style="list-style-type: none"> <li>• Slings – Round</li> <li>• Slings – Flat</li> <li>• Chain - High Tensile</li> <li>• Chain Fittings</li> <li>• Cow Slings</li> </ul>
<p><b>BARS AND BEAMS</b></p> <ul style="list-style-type: none"> <li>• Shoring Bars</li> <li>• Decking Beams</li> <li>• Cargo Sta Bars</li> </ul>	<p><b>TRACK</b></p> <ul style="list-style-type: none"> <li>• E Series Combination Track</li> <li>• F Series Track</li> <li>• Aircraft Series Track</li> <li>• Rope Tie Offs</li> </ul>	<p><b>MOTOR BODY BUILDERS HARDWARE</b></p> <ul style="list-style-type: none"> <li>• Cam Line Sets</li> <li>• Door Hinges</li> <li>• Door Seal Rubber</li> <li>• Twist Locks</li> <li>• Corner Castings</li> <li>• U Bolts</li> <li>• Pan Fittings</li> <li>• Bottom Strap Assemblies</li> <li>• Spring Bolts</li> </ul>	<p><b>VEHICLE CARRYING</b></p> <ul style="list-style-type: none"> <li>• Specialty Straps</li> <li>• Hooks and Fittings</li> </ul>
<p><b>ROPE</b></p> <ul style="list-style-type: none"> <li>• Silver Rope Various Lengths and Diameters</li> <li>• 250m Rolls</li> <li>• Pallet Angles</li> </ul>	<p><b>CONSUMER TIEDOWNS</b></p> <ul style="list-style-type: none"> <li>• Motorcycle Tie Downs</li> <li>• Boat Tie Downs</li> <li>• Boat Winch Straps</li> <li>• Cargo Straps</li> <li>• Specialty Consumer Straps</li> </ul>	<p><b>TRAILER LOADING &amp; STORAGE SYSTEMS</b></p> <ul style="list-style-type: none"> <li>• Lift A Deck</li> <li>• Fold A Deck</li> <li>• Retract A Roll</li> <li>• Pallet Skates</li> </ul>	<p><b>AIRCRAFT EQUIPMENT</b></p> <ul style="list-style-type: none"> <li>• Aircraft Rated Track</li> <li>• Aircraft Rated Parts</li> <li>• Aircraft Rated Fitting Kits</li> </ul>

**FOR MORE ANCRA PRODUCTS  
REFER TO ANCRA MAIN  
CATALOGUE OR ONLINE AT**

**[www.ancranz.co.nz](http://www.ancranz.co.nz)**